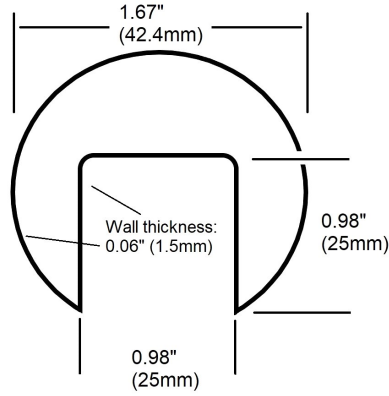

47-A114U 1.67" OD x 0.06" Channel Tubing - 316 Grade Polished Stainless Steel

47-A114U architectural round channel tube is available in stainless steel, has a 1.67" outside diameter, a 0.06" wall thickness, and is available in stock lengths up to 16 feet.

This tube is commonly used as a cap rail (top rail) on glass.

Hardware Included:

No hardware is included with this item.

Material Care:

Maintain a polished finish with metal polish, item# 00202. Apply with a soft, damp cloth.

Related Items:

Connect the tube to the glass using Rubber Channel Tube Insert, item# CTI.

Connect lengths of tube using our internal splice, item# 830U.

Use adhesive, item# LB-00201 together with activator, item# 00211 to connect tube to fittings.

Shipping:

Lengths up to 8 feet can ship by UPS.

Lengths longer than 8 feet ship by LTL freight (truck).

Custom cut lengths can be made.

Call toll free at 877-810-4116 to talk to a specialist about your specific application.