

52-50240 Straight Section Kit, Aluminum, 8 ft., Bright Dip Anodized - 2 posts with 45SBC

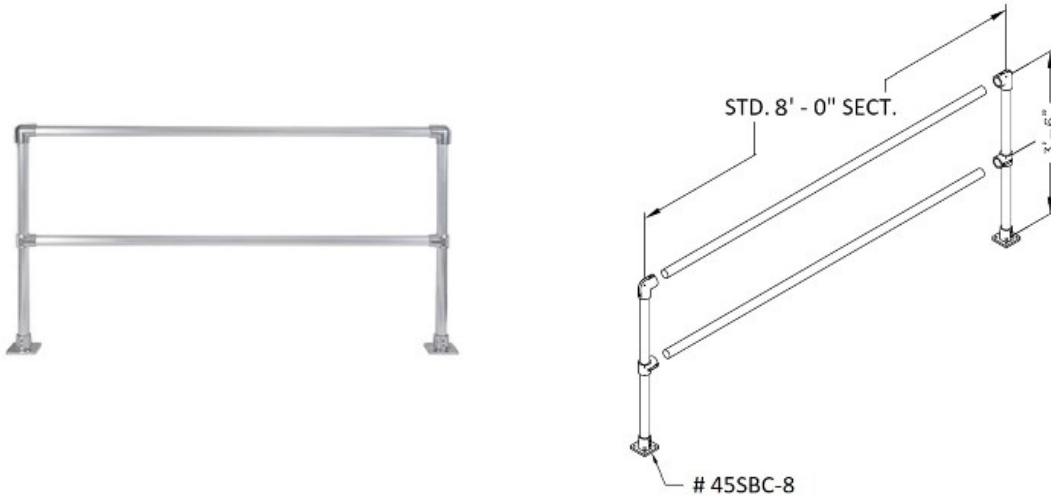

The Bright Dip Anodized Aluminum Double Line Safety Straight Kit consists of

- * Two end posts
- * Horizontal top and mid rails

This kit has one section that extends 8 feet (post center to post center).

Material Specs:

Posts: Bright Dip Anodized Aluminum 6063-T6, 1 ½" IPS, Schedule 40/.145 wall (1.90 O.D.)

Rails: Bright Dip Anodized Aluminum 6063-T6, 1 ½" IPS, Schedule 40/.145 wall (1.90 O.D.)

Speed-Rail® Components: 535 Almag aluminum magnesium sand cast alloy, per ASTM B26