

**50220** Straight Section Kit, Aluminum, 4 ft., Mill finish - 2 posts with 45SBC

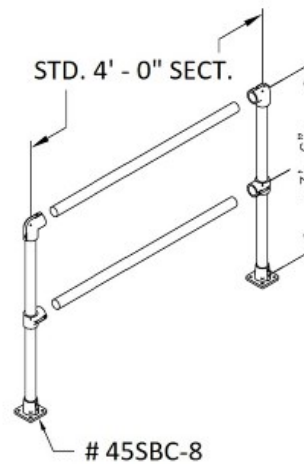

The Mill Finish Aluminum Double Line Safety Straight Kit consists of

- \* Two end posts
- \* Horizontal top and mid rails

This kit has one section that extends 4 feet (post center to post center).

**Material Specs:**

**Posts:** ASTM B429 Mill Aluminum 6063-T6, 1 ½" IPS, Schedule 40/.145 wall (1.90 O.D.)

**Rails:** ASTM B429 Mill Aluminum 6063-T6, 1 ½" IPS, Schedule 40/.145 wall (1.90 O.D.)

**Speed-Rail® Components:** 535 Almag aluminum magnesium sand cast alloy, per ASTM B26